

# Clarion®

Owner's manual  
Mode d'emploi  
Manual de instrucciones

## ***RDX655Dz***

AM/FM CD PLAYER  
WITH CD/MD CHANGER CONTROL

LECTEUR CD AM/FM AVEC  
COMMANDE DE CHANGEUR CD/MD

RADIO DE AM/FM Y REPRODUCTOR DE DISCOS  
COMPACTOS CON CONTROL DE CAMBIADOR  
DE DISCOS COMPACTOS/MINIDISCOS

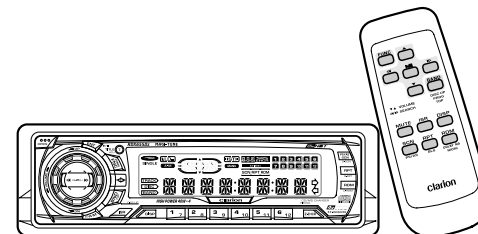

### **Clarion Co., Ltd.**

All Rights Reserved. Copyright © 1998: Clarion Co., Ltd.  
Printed in China / Imprimé en Chine / Inpreso en China

PE-2190B  
280-7250-00



Thank you for purchasing the **Clarion RDX655Dz**.

- \* Please read this owner's manual in its entirety before operating this equipment.
- \* After reading this manual, be sure to keep it in a handy place (e.g., glove compartment).
- \* Check the contents of the enclosed warranty card and keep it carefully with this manual.
- \* This manual includes the operating procedures of the CD changer, MD changer and TV tuner connected via the CeNET cable. The CD changer, MD changer and TV tuner have their own manuals, but no explanations for operating them are described.

## Contents

1. FEATURES .....	2
2. PRECAUTIONS .....	3
Handling Compact Discs .....	4
Flip Down Panel .....	4
3. CONTROLS .....	5
4. NOMENCLATURE .....	6
Names of Buttons .....	6
Display Items .....	6
5. DCP .....	7
6. REMOTE CONTROL .....	8
Inserting the Batteries .....	8
Functions of Remote Control Unit Buttons .....	9
7. OPERATIONS .....	10
Basic Operations .....	10
Radio Operations .....	12
CD Operations .....	14
Other Handy Functions .....	15
8. OPERATIONS OF ACCESSORIES .....	17
CD Changer Operations .....	17
MD Changer Operations .....	19
TV Operations .....	20
9. TROUBLESHOOTING .....	22
10. ERROR DISPLAYS .....	23
11. SPECIFICATIONS .....	24

## 1. FEATURES

- Rotary Encoder Volume Control with Illuminated Search Key
- Touch-n-GO Flip Down Detachable Face
- Capability to Read CD TEXT Data from Clarion Compatible CD Changer
- Z-Enhancer with 3 Adjustment Modes
- CeNET with Balanced Audio Line Transmission and Dynamic Noise Canceling
- **MAGI-TUNE**® FM Reception System
- 8-Times Oversampling Digital Filter and Dual 1-Bit D/A Converters
- Zero-Bit Detector™ Mute Circuit
- 4V/4-Channel RCA Line Level Output with Fader Control
- 160W (40W × 4) Maximum Power Output

## 6. REMOTE CONTROL

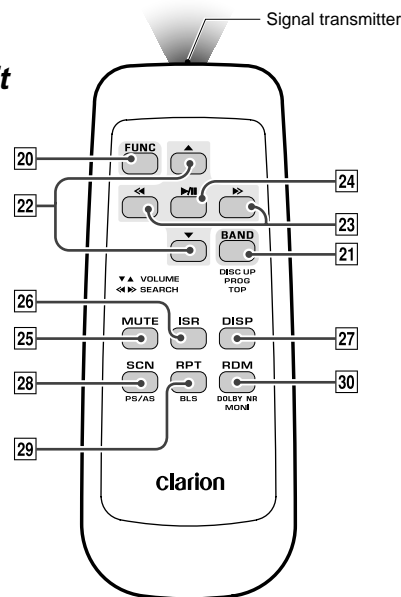
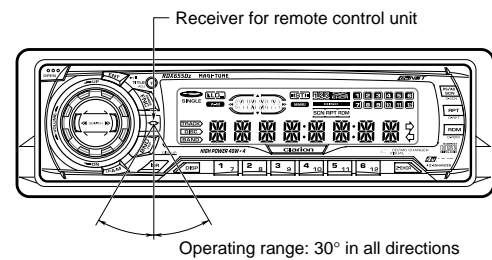

Remote control unit

### Inserting the Batteries

1. Turn the remote control unit over, then slide the rear cover in the direction of the arrow.
2. Insert the AA (UM-3/1.5V) batteries that came with the remote control unit facing in the directions shown in the figure, then close the rear cover.

#### Notes:

Using batteries improperly can cause them to explode. Take note of the following points:

- When replacing batteries, replace both batteries with new ones.
- Do not short-circuit, disassemble or heat batteries.
- Do not dispose of batteries into fire or water.
- Dispose of spent batteries properly.

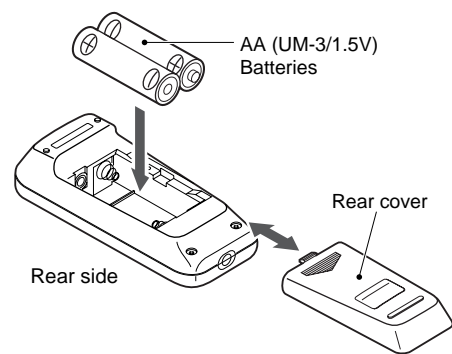

## 2. PRECAUTIONS

1. When the inside of the car is very cold and the player is used soon after switching on the heater moisture may form on the disc or the optical parts of the player and proper playback may not be possible. If moisture forms on the disc, wipe it off with a soft cloth. If moisture forms on the optical parts of the player, do not use the player for about one hour. The condensation will disappear naturally allowing normal operation.
2. Driving on extremely bumpy roads which cause severe vibration may cause the sound to skip.
3. This unit uses a precision mechanism. Even in the event that trouble arises, never open the case, disassemble the unit, or lubricate the rotating parts.

This equipment has been tested and found to comply with the limits for a Class B digital device, pursuant to Part 15 of the FCC Rules.

These limits are designed to provide reasonable protection against harmful interference in a residential installation.

This equipment generates, uses, and can radiate radio frequency energy and, if not installed and used in accordance with the instructions, may cause harmful interference to radio communications. However, there is no guarantee that interference will not occur in a particular installation.

If this equipment does cause harmful interference to radio or television reception, which can be determined by turning the equipment off and on, the user is encouraged to consult the dealer or an experienced radio/TV technician for help.

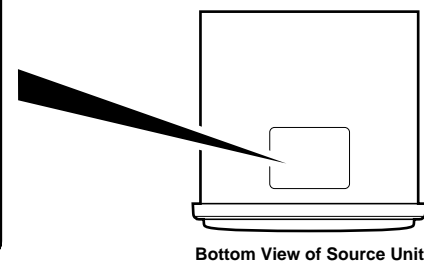
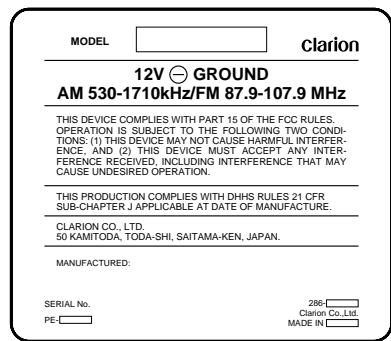

Bottom View of Source Unit

### CAUTION

USE OF CONTROLS, ADJUSTMENTS, OR PERFORMANCE OF PROCEDURES OTHER THAN THOSE SPECIFIED HEREIN, MAY RESULT IN HAZARDOUS RADIATION EXPOSURE.

THE COMPACT DISC PLAYER and MINI DISC PLAYER SHOULD NOT BE ADJUSTED OR REPAIRED BY ANYONE EXCEPT PROPERLY QUALIFIED SERVICE PERSONNEL.

CHANGES OR MODIFICATIONS NOT EXPRESSLY APPROVED BY THE MANUFACTURER FOR COMPLIANCE COULD VOID THE USER'S AUTHORITY TO OPERATE THE EQUIPMENT.

#### INFORMATION FOR USERS:

CHANGES OR MODIFICATIONS TO THIS PRODUCT NOT APPROVED BY THE MANUFACTURER WILL VOID THE WARRANTY AND WILL VIOLATE FCC APPROVAL.

## Handling Compact Discs

Use only compact discs bearing the  mark.

Do not play heart-shaped, octagonal, or other specially shaped compact discs.

### Handling

- New discs may have some roughness around the edges. If such discs are used, the player may not work or the sound may skip. Use a ball-point pen or the like to remove any roughness from the edge of the disc.

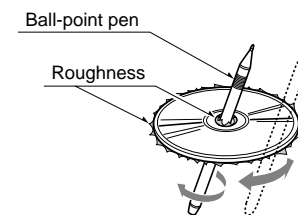

- Never stick labels on the surface of the compact disc or mark the surface with a pencil or pen.
- Never play a compact disc with any cellophane tape or other glue on it or with peeling off marks. If you try to play such a compact disc, you may not be able to get it back out of the CD player or it may damage the CD player.
- Do not use compact discs that have large scratches, are misshapen, cracked, etc. Use of such discs may cause misoperation or damage.

- To remove a compact disc from its storage case, press down on the center of the case and lift the disc out, holding it carefully by the edges.
- Do not use commercially available CD protection sheets or discs equipped with stabilizers, etc. These may damage the disc or cause breakdown of the internal mechanism.

### Storage

- Do not expose compact discs to direct sunlight or any heat source.
- Do not expose compact discs to excess humidity or dust.
- Do not expose compact discs to direct heat from heaters.

### Cleaning

- To remove fingermarks and dust, use a soft cloth and wipe in a straight line from the center of the compact disc to the circumference.
- Do not use any solvents, such as commercially available cleaners, anti-static spray or thinner to clean compact discs.
- After using special compact disc cleaner, let the compact disc dry off well before playing it.

## Flip Down Panel

The RDX655Dz uses a flip-down structure that makes possible large-size displays.

### CAUTION

When opening and closing the FLIP DOWN PANEL, be careful not to catch your fingers. They could be injured.

1. Always use the RDX655Dz with the FLIP DOWN PANEL closed.
2. Do not force operations or use this device abnormally when opening or closing the FLIP DOWN PANEL.

3. Do not use the FLIP DOWN PANEL as a tray to place objects on when it is open.
4. When closing the FLIP DOWN PANEL, do not press OPEN button .
5. Strong impacts to the operating or display section can cause damage or deformation.
6. If the FLIP DOWN PANEL does not open fully, gently open it with your hand.

Be sure to unfold and read the next page.  
Veuillez déplier et vous référer à la page suivante.  
Cerciórese de desplegar y de leer la página siguiente.

## 3. CONTROLS / LES COMMANDES / CONTROLES

Source unit / Appareil pilote / Unidad fuente

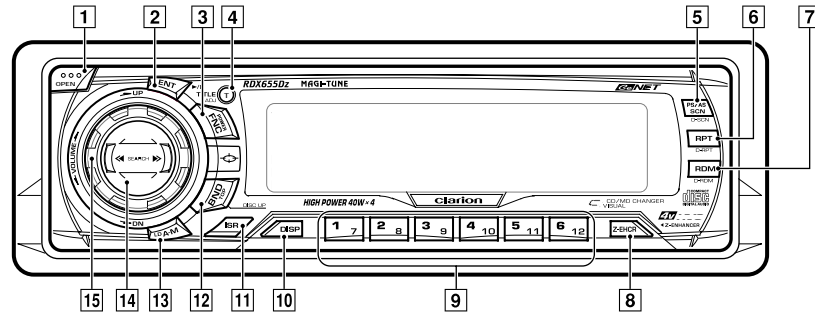

With the FLIP DOWN PANEL opened / Ouverture du PANNEAU RABATTABLE / Apertura del PANEL ABATIBLE

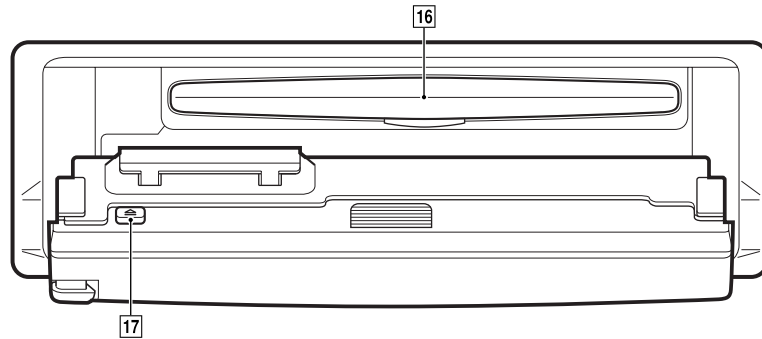

Display / Afficheur / Visualizador

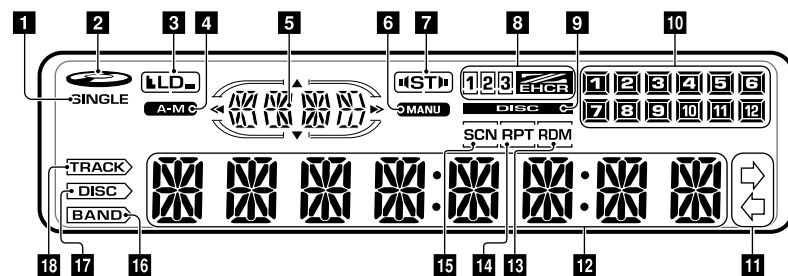

**Note:** Be sure to unfold this page and refer to the front diagrams as you read each chapter.

**Remarque:** Veuillez déplier cette page et vous référer aux schémas quand vous lisez chaque chapitre.

**Nota:** Cuando lea los capítulos, despliegue esta página y consulte los diagramas.

## 4. NOMENCLATURE

**Note:**

• Be sure to read this chapter referring to the front diagrams of chapter "3. CONTROLS" on page 5 (unfold).

### Names of Buttons

- |   |   |
|---|---|
| <p>1 OPEN button</p> <p>2 ENT (enter) button<br/>Play/pause button</p> <p>3 POWER button<br/>FNC (function) button</p> <p>4 TITLE button<br/>ADJ (adjust) button</p> <p>5 SCN (scan) button<br/>PS/AS (preset scan/auto store) button</p> <p>6 RPT (repeat) button</p> <p>7 RDM (random) button</p> <p>8 Z-EHCR (z-enhancer) button</p> | <p>9 Preset buttons (1 to 6)<br/>Direct buttons (1 to 6) (7 to 12)</p> <p>10 DISP (display) button</p> <p>11 ISR (instant station recall) button</p> <p>12 BND (band) button<br/>TOP button</p> <p>13 A-M (audio mode) button<br/>LD (loudness) button</p> <p>14 SEARCH button</p> <p>15 Rotary knob</p> <p>16 CD insertion slot</p> <p>17 Eject button</p> |
|---|---|

### Display Items

- |   |   |
|---|---|
| <p>1 Single disc indication</p> <p>2 Disc in indication</p> <p>3 LD (loudness) indication</p> <p>4 A-M (audio mode) indication</p> <p>5 Function mode indication<br/>* The names of modes being selected, etc. are displayed.</p> <p>6 MANU (manual) indication</p> <p>7 ST (stereo) indication</p> <p>8 Z-EHCR (z-enhancer) indication</p> <p>9 DISC indication</p> <p>10 Preset channel indication (1 to 6)<br/>Disc number indication (1 to 12)<br/>* The disc numbers corresponding to the discs in the CD or MD changer light.</p> | <p>11 Long title indication</p> <p>12 Operation status indication<br/>* The frequency, play time, clock, etc. are displayed.</p> <p>13 RDM (random) indication</p> <p>14 RPT (repeat) indication</p> <p>15 SCN (scan) indication</p> <p>16 BAND indication</p> <p>17 DISC TITLE indication</p> <p>18 TRACK indication</p> |
|---|---|

## 5. DCP

The control panel can be detached to prevent theft. When detaching the control panel, store it in the DCP (DETACHABLE CONTROL PANEL) case to prevent scratches.

We recommend taking the DCP with you when leaving the car.

### Removing the DCP

1. Hold down POWER button 3 for 1 second or longer to turn off the power.

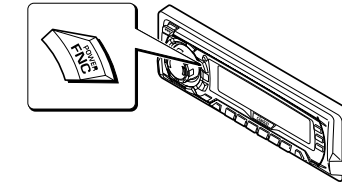

2. Deeply push in OPEN button 1 to unlock the FLIP DOWN PANEL.

\* If the FLIP DOWN PANEL does not open fully, gently open it with your hand.

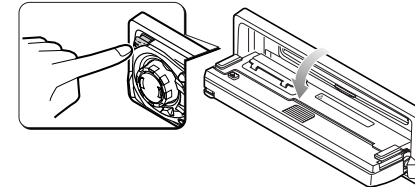

3. Pull the DCP toward you and remove it.

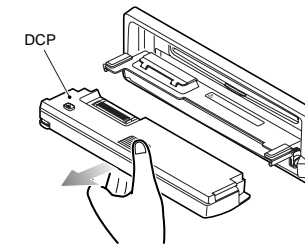

4. Close the HOLD FLAP.

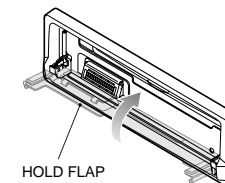

### Attaching the DCP

1. Insert the right side of the DCP into the source unit.
2. Insert the left side of the DCP into the source unit.

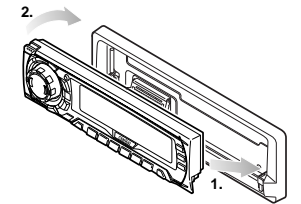

### CAUTION

- The DCP can easily be damaged by shocks. After removing it, be careful not to drop it or subject it to strong shocks.
- If the FLIP DOWN PANEL is kept open, the DCP may drop due to vibration of the car. This results in damage to the DCP. So close the FLIP DOWN PANEL or remove the DCP to store into the case.
- The connector connecting the source unit and the DCP is an extremely important part. Be careful not to damage it by pressing on it with fingernails, screwdrivers, etc.

**Note:**

- If the DCP is dirty, wipe off the dirt with a soft, dry cloth only.

### CAUTION

Be sure to close the HOLD FLAP for safety when removing the DCP.

# Functions of Remote Control Unit Buttons

Button	Mode	Radio	CD	CD changer MD changer	TV
20	FUNC	Turns power on and off. When pressed and held for 1 second: Turns power off. Switches among radio, CD, CD changer, MD changer and TV.			
21	BAND DISC UP PROG TOP	Switches reception band.	Plays the first track. Top play.	Moves the next disc in increasing order.	Switches reception band.
22	VOLUME	Increases and decreases volume (in all modes).			
23	SEARCH	Moves preset channels up and down.	Moves tracks up and down. When pressed and held for 1 second: Fast-forward/ fast-backward.	Moves tracks up and down. When pressed and held for 1 second: Fast-forward/ fast-backward.	Moves preset channels up and down.
24	PLAY/PAUSE	No function.	Switches between playback and pause.	Switches between playback and pause.	No function.
25	MUTE	Turns mute on and off.			
26	ISR	Recalls ISR radio station in memory. Press and hold for 2 seconds or longer: Stores current station into ISR memory (radio mode only).			
27	DISP	Switches among main display, sub display and clock display.			
28	SCN PS/AS	Preset scan. When pressed and held for 2 seconds: Auto store.	Scan play.	Scan play. When pressed and held for 2 seconds: Disc scan play.	Preset scan. When pressed and held for 2 seconds: Auto store.
29	RPT BLS	No function.	Repeat play.	Repeat play. When pressed and held for 2 seconds: Disc repeat play.	No function.
30	RDM DOLBY NR MONI	No function.	Random play.	Random play. When pressed and held for 2 seconds: Disc random play.	Switches between TV and VTR.

\* Some of the corresponding buttons on the source unit and remote control unit have different functions.

# 7. OPERATIONS

## Basic Operations

**Note:** Be sure to read this chapter referring to the front diagrams of chapter "3. CONTROLS" on page 5 (unfold).

### ⚠ CAUTION

Be sure to lower the volume before switching off the unit power or the ignition key. The unit remembers its last volume setting. If you switch the power off with the volume up, when you switch the power back on, the sudden loud volume may hurt your hearing and damage the unit.

The clock is displayed when the ignition key is turned to the ACC (accessory) or IGN (ignition-on) position even when the unit power is off. In some cars, the clock may momentarily disappear when the ignition key is turned to the START position. The clock will reappear after the engine has started and the ignition key is released to the IGN (ignition-on) position.

### Turning on/off the power

#### Note:

• Be careful about using this unit for a long time without running the engine. If you drain the car's battery too far, you may not be able to start the engine and this can reduce the service life of the battery.

1. Press POWER button [3].
2. The illumination and display on the unit light up. The unit automatically remembers its last operation mode and will automatically switch to display that mode.
3. Press and hold POWER button [3] for 1 second or longer to turn off the power for the unit.

#### Note:

##### • System check

The first time this unit is turned on after the wire connections are completed, it must be checked what equipment is connected. When the power is turned on, "SYSTEM CHCK" appears in the display, so press POWER button [3]. The system check starts within the unit. When the system check is complete, the power is turned off, so press POWER button [3] again.

### Selecting a mode

1. Press FNC button [3] to change the mode of operation.
2. Each time you press FNC button [3], the mode of operation changes in the following order:

Radio mode → CD mode → CD changer mode → MD changer mode → TV mode → Radio mode...

\* External equipment not connected with CeNET is not displayed.

### Adjusting the volume

Turning the Rotary knob [15] clockwise increases the volume; turning it counterclockwise decreases the volume.

\* The volume level is from 0 (minimum) to 33 (maximum).

### Switching the display

Press DISP button [10] to select the desired display. Each time you press DISP button [10], the display switches in the following order:

Main display



Sub (title) display

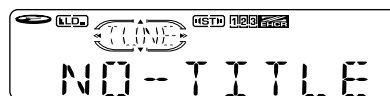

Clock display

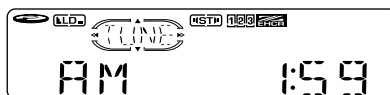

Main display...

\* Once selected, the preferred display becomes the display default. When a function adjustment such as volume is made, the screen will momentarily switch to that function's display, then revert back to the preferred display several seconds after the adjustment.

- \* When you have entered a title in a CD, it appears in the sub display. If you have not entered a title, "NO-TITLE" appears in the title display instead. For information on how to enter a title, refer to the subsection "Entering titles" in the "Other Handy Functions".

### Setting the Z-enhancer

This unit comes with 3 types of sound tone effects stored in memory. Select the one you prefer.

- \* The factory default setting is "OFF".

Each time you press Z-EHCR button [8], the tone effect changes in the following order:

"Z-ENHANCER 1" → "Z-ENHANCER 2" → "Z-ENHANCER 3" → "OFF" → "Z-ENHANCER 1"...

- Z-ENHANCER 1: bass emphasized
- Z-ENHANCER 2: treble emphasized
- Z-ENHANCER 3: bass and treble emphasized
- OFF : no sound effect

### Adjusting the tone

Press A-M button [13] and select the item to adjust. Each time you press A-M button [13], the item changes in the following order:

- When Z-enhancer 1, 2 or 3 is set  
"Z-EHCR" → "BAL" → "FAD" → Function mode...

### Adjusting the bass

1. Press A-M button [13] and select "BASS".
2. Turning the Rotary knob [15] clockwise emphasizes the bass; turning it counterclockwise attenuates the bass.
  - \* The factory default setting is "0". (Adjustment range: -6 to +6)
3. When the adjustment is complete, press A-M button [13] several times until the function mode is reached.

### Adjusting the treble

1. Press A-M button [13] and select "TREB".
2. Turning the Rotary knob [15] clockwise emphasizes the treble; turning it counterclockwise attenuates the treble.
  - \* The factory default setting is "0". (Adjustment range: -6 to +6)
3. When the adjustment is complete, press A-M button [13] several times until the function mode is reached.

### Adjusting the balance

1. Press A-M button [13] and select "BAL".
2. Turning the Rotary knob [15] clockwise emphasizes the sound from the right speaker; turning it counterclockwise emphasizes the sound from the left speaker.
  - \* The factory default setting is "0". (Adjustment range: L13 to R13)
3. When the adjustment is complete, press A-M button [13] several times until the function mode is reached.

### Adjusting the fader

1. Press A-M button [13] and select "FAD".
2. Turning the Rotary knob [15] clockwise emphasizes the sound from the front speakers; turning it counterclockwise emphasizes the sound from the rear speakers.
  - \* The factory default setting is "0". (Adjustment range: F12 to R12)
3. When the adjustment is complete, press A-M button [13] several times until the function mode is reached.

### Adjusting the Z-enhancer

1. Press Z-EHCR button [8] and select the Z-enhancer mode (1 to 3) to adjust.
2. Press A-M button [13] and select "Z-EHCR".
3. Turning the Rotary knob [15] clockwise adjusts in the + direction; turning it counterclockwise adjusts in the - direction.
  - \* When Z-enhancer 1 is selected, you can adjust the bass in the range of  $\pm 2$ .
  - \* When Z-enhancer 2 is selected, you can adjust the treble in the range of  $\pm 2$ .
  - \* When Z-enhancer 3 is selected, you can adjust the bass and treble in the range of  $\pm 2$ .
4. When the adjustment is complete, press A-M button [13] several times until the function mode is reached.

### Turning on/off the loudness

The loudness effect emphasizes the bass and treble to create a natural sound tone. When you are listening to music at a low volume, it is recommended to use the loudness effect.

1. Press and hold LD button [13] for 1 second or longer to turn on the loudness effect. When the loudness effect is turned on, "LD" lights in the display.
2. Press and hold LD button [13] for 1 second or longer to turn off the loudness effect. "LD" goes off in the display.

### FM reception

For enhanced FM performance the **MAGI-TUNE**® tuner includes signal actuated stereo control and Multipath noise reduction circuits.

### Changing the reception area

This unit is initially set to USA frequency intervals of 10kHz for AM and 200kHz for FM. When using it outside the USA, the frequency reception range can be switched to the intervals below.

#### ● Setting the reception area

1. Press BND button [12] and select the desired radio band (FM or AM).
2. While pressing RDM button [7], each time you press and hold the number "1" of the Preset buttons [9] for 2 seconds or longer, the reception area switches from inside the USA to outside the USA or from outside the USA to inside the USA.
  - \* Any station preset memories are lost when the reception area is changed.

### Listening to the radio

1. Press FNC button [3] and select the radio mode.
2. Press BND button [12] and select the radio band. Each time the button is pressed, the radio reception band changes in the following order:  
FM1 → FM2 → FM3 → AM → FM1...
3. Press the right or left side of SEARCH button [14] to tune in the desired station.

### Tuning

There are 3 types of tuning mode available, seek tuning, manual tuning and preset tuning.

### Seek tuning

1. Press BND button [12] and select the desired band (FM or AM).
  - \* If "MANU" is lit in the display, press and hold BND button [12] for 1 second or longer. "MANU" in the display goes off and seek tuning is now available.
2. Press the right or left side of SEARCH button [14] to automatically seek a station. When the right side of SEARCH button [14] is pressed, the station is sought in the direction of higher frequencies; if the left side of SEARCH button [14] is pressed, the station is sought in the direction of lower frequencies.



## Manual tuning

There are 2 ways available: Quick tuning and step tuning.

When you are in the step tuning mode, the frequency changes one step at a time. In quick tuning mode, you can quickly tune the desired frequency.

1. Press BND button [12] and select the desired band (FM or AM).

\* If "MANU" is not lit in the display, press and hold BND button [12] for 1 second or longer. "MANU" lights in the display and manual tuning is now available.

2. Tune into a station.

### ● Quick tuning:

Press and hold the right or left side of SEARCH button [14] for 1 second or longer to tune in a station.

### ● Step tuning:

Press the right or left side of SEARCH button [14] to manually tune in a station.

## Recalling a preset station

A total of 24 preset positions (6-FM1, 6-FM2, 6-FM3, 6-AM) exists to store individual radio stations in memory. Pressing the corresponding preset button recalls the stored radio frequency automatically.

1. Press BND button [12] and select the desired band (FM or AM).
2. Press the corresponding Preset button [9] to recall the stored station.

\* Press and hold one of the Preset buttons [9] for 2 seconds or longer to store that station into preset memory.

## Manual memory

1. Select the desired station with seek tuning, manual tuning or preset tuning.
2. Press and hold one of the Preset buttons [9] for 2 seconds or longer to store the current station into preset memory.

## Auto store

Auto store is a function for storing up to 6 stations that are automatically tuned in sequentially. If 6 stations cannot be received, a previously stored station remains unoverwritten at the memory position.

1. Press BND button [12] and select the desired band (FM or AM).
2. Press and hold AS button [5] for 2 seconds or longer. The stations with good reception are stored automatically to the preset buttons.

## Preset scan

Preset scan receives the stations stored in preset memory in order. This function is useful when searching for a desired station in memory.

1. Press PS button [5].
2. When a desired station is tuned in, press PS button [5] again to continue receiving that station.

### Note:

• Be careful not to press and hold PS button [5] for 2 seconds or longer, otherwise the auto store function engages and the unit starts storing stations.

## Instant station recall (ISR)

Instant station recall is a special radio preset that instantly accesses a favorite radio station at a touch of a button. The ISR function even operates with the unit in other modes.

### ● ISR memory

1. Select the station that you wish to store in ISR memory.
2. Press and hold ISR button [11] for 2 seconds or longer.

### ● Recalling a station with ISR

In any mode, press ISR button [11] to turn on the radio function and tune the selected radio station. "ISR" appears in the display. Press ISR button [11] again to return to the previous mode.

# CD Operations

## Loading a CD

1. Press OPEN button **[1]** to access the CD insertion slot behind the FLIP DOWN PANEL.
2. Insert a CD into the center of the insertion slot with the label side facing up. The CD plays automatically after loading.

### Notes:

- Never insert foreign objects into the CD insertion slot.
- If the CD is not inserted easily, there may be another CD in the mechanism or the unit may require service.
- Discs not bearing the  mark and CD-ROMs cannot be played by this unit.

Loading 3" (8 cm) compact discs

- \* No adapter is required to play a 3" CD.
  - \* Insert the 3" CD into the center of the insertion slot.
  - \* When a 3" CD is loaded, "SINGLE" lights in the display.
3. Close the FLIP DOWN PANEL.

## CAUTION

**Be careful not to catch your hand or fingers while closing the FLIP DOWN PANEL.**

### Notes:

- If the FLIP DOWN PANEL does not open fully, gently open with your hand.
- After loading a CD, always close the FLIP DOWN PANEL.

## Listening to a CD already inserted

Press FNC button **[3]** to select the CD mode. Play starts automatically. If no CD is loaded in the unit, "NO DISC" appears in the display.

## Pausing play

1. Press Play/pause button **[2]** to pause play. "PAUS" appears in the display.
2. To resume CD play, press Play/pause button **[2]** again.

## Ejecting a CD

1. Press OPEN button **[1]** to open the FLIP DOWN PANEL.
2. Press Eject button **[17]** to eject the CD. Take it out from the ejected position.
  - \* "DISC CHK" appears in the display when the CD is left in the ejected position.
3. Close the FLIP DOWN PANEL.

## CAUTION

**Be careful not to catch your hand or fingers while closing the FLIP DOWN PANEL.**

### Notes:

- If the FLIP DOWN PANEL does not open fully, gently open with your hand.
- After taking out the CD, be sure to close the FLIP DOWN PANEL.
- \* If a CD (12 cm) is left in the ejected position for 15 seconds, the CD is automatically reloaded (Auto reload).
- \* 3" CDs (8 cm) are not auto reloaded. Be sure to remove it when ejected.

### Notes:

- If you force a CD into before auto reloading, this can damage the CD.
- "DISC CHK" in the display shows you a CD is left in the unit. Be sure to press Eject button **[17]** and remove it in this case.

## Selecting a track

### ● Track-up

1. Press the right side of SEARCH button **[14]** to move ahead to the beginning of the next track.
2. Each time you press the right side of SEARCH button **[14]**, the track advances ahead to the beginning of the next track.

### ● Track-down

1. Press the left side of SEARCH button **[14]** to move back to the beginning of the current track.
2. Press the left side of SEARCH button **[14]** twice to move to the beginning of the previous track.

## Fast-forward/fast-backward

### ● Fast-forward

Press and hold the right side of SEARCH button **[14]** for 1 second or longer.

### ● Fast-backward

Press and hold the left side of SEARCH button **[14]** for 1 second or longer.

## Top function

The top function resets the CD player to the first track of the disc. Press TOP button **[12]** to play the first track (track No. 1) on the disc.

### Scan play

The scan play locates and plays the first 10 seconds of each track on a disc automatically. This function continues on the disc until it is canceled.

\* The scan play is useful when you want to select a desired track.

1. Press SCN button [5] to start track scanning. "SCN" lights in the display.
2. To cancel the scan play, press SCN button [5] again. "SCN" goes off from the display and the current track continues to play.

### Repeat play

The repeat play continuously plays the current track. This function continues automatically until it is canceled.

1. Press RPT button [6]. "RPT" lights in the display and the current track is repeated.
2. To cancel the repeat play, press RPT button [6] again. "RPT" goes off from the display and normal play resumes.

### Random play

The random play selects and plays individual tracks on a disc in no particular order. This function continues automatically until it is canceled.

1. Press RDM button [7]. "RDM" lights in the display, an individual track is selected randomly and play begins.
2. To cancel the random play, press RDM button [7] again. "RDM" goes off from the display and normal play resumes.

### Setting the clock

1. Press and hold ADJ button [4] for 1 second or longer to switch to the adjustment selection display.
2. Press the right or left side of SEARCH button [14] to select "CLOCK".
3. Press ENT button [2].
4. Press the right or left side of SEARCH button [14] to select the hour or the minute.
5. Turn the Rotary knob [15] clockwise or counterclockwise to set the correct time.
  - \* The clock is displayed in 12-hour format.
6. Press ENT button [2] to store the time into memory.
7. Press ADJ button [4] to return to the previous mode.

#### Note:

\* You cannot set the clock when it is displayed with only the ignition on. If you drain or remove the car's battery or take out this unit, the clock is reset. While setting the clock, if another button or operation is selected, the clock set mode is canceled.

### Entering titles

Titles up to 10 characters long can be stored in memory and displayed for radio stations and CDs. The numbers of titles that can be entered for each mode are as follows.

Mode	Number of titles
Radio mode	30 titles
CD mode	50 titles
TV mode	15 titles

CD changer mode	Number of titles
RDC655z connected	60 titles
RDC655Tz connected	100 titles
RDC1255z connected	50 titles

1. Press FNC button [3] to select the mode you want to enter a title. (radio, CD, CD changer or TV)
  - \* Titles cannot be entered for MDs with this unit.
2. Select and play a CD or a CD in the CD changer or tune to an appropriate TV or radio station.
3. Press DISP button [10] and display the subtitle.
4. Press TITLE button [4]. "TITL" appears in the display and the cursor position flashes.
5. Press the right or left side of SEARCH button [14] to move the cursor.

6. Press DISP button [10] to select a character. Each time you press DISP button [10], the character changes in the following order:  
Capital letters → Numbers → Capital letters...
7. Turn the Rotary knob [15] to select the desired character. Turning the Rotary knob [15] clockwise moves the cursor to the next character; turning it counterclockwise moves the cursor to the previous character.
8. Repeat steps 5 to 7 to enter up to 10 characters for the title.
9. Press and hold ENT button [2] for 2 seconds or longer to store the title into memory and cancel title input mode.

### Clearing titles

1. Play a CD or a CD in a CD changer or tune a radio station or TV station that you want to clear the title for.
2. Press DISP button [10] and display the subtitle.
3. Press TITLE button [4]. "TITL" appears in the display and the display switches to the title input display.
4. Press BND button [12].
5. Press and hold ENT button [2] for 2 seconds or longer to clear the title and cancel the title input mode.

### Message display

When the unit is powered on or off, a message is displayed. The user can turn this message display on or off.

\* The factory default setting is "ON".

1. Press and hold ADJ button [4] for 1 second or longer to switch to the adjustment selection display.
2. Press the right or left side of SEARCH button [14] to select "MESSAGE".
3. Press ENT button [2].
4. Turn the Rotary knob [15] clockwise to set the message display to "ON"; turn it counterclockwise to set the message display to "OFF".
5. Pressing ENT button [2] returns to the adjustment selection display.
6. Press ADJ button [4] to return to the previous mode.

# 8. OPERATIONS OF ACCESSORIES

## CD Changer Operations

### CD changer functions

When an optional CD changer is connected through the CeNET cable, this unit controls all the CD changer functions. This unit can control a total of 2 changers (MD and/or CD).

Press FNC button [3] and select the CD changer mode to start play. If 2 CD changers are connected, press FNC button [3] to select the CD changer for play.

\* If "NO MAG" appears in the display, insert the magazine into the CD changer. "LOADING" appears in the display while the player loads (checks) the magazine.

\* If "NO DISC" appears in the display, eject the magazine and insert discs into each slot. Then, reinsert the magazine back into the CD changer.

### ⚠ CAUTION

**CD-ROM discs cannot be played in the CD changer.**

### Pausing play

1. Press Play/pause button [2] to pause play. "PAUS" appears in the display.
2. To resume play, press Play/pause button [2] again.

### Displaying CD titles

This unit can display title data for CD-text CDs and user titles input with this unit.

1. Press DISP button [10] to display the title.
2. Each time you press and hold DISP button [10] for 1 second or longer, the title display changes in the following order:  
User title (disc) → CD-text title (disc) → CD-text title (track) → user title (disc)...

#### Note:

• If the CD playing is not a CD-text CD or no user title has been input, "NO-TTL" appears in the display.

#### ● Scrolling a CD-text title

When a CD-text title is longer than 11 characters, you can scroll the display as follows.

1. Display the CD-text title (disc or track).
2. Press TITLE button [4]. The title scrolls.

### Selecting a CD

Each of the Direct button [9] corresponds to a disc loaded into the magazine.

#### ● Selecting a disc from 1 to 6

Press the corresponding Direct button [9] (1 to 6) to select the desired disc.

#### ● Selecting a disc from 7 to 12 (only when a 12 disc CD changer is used.)

Press and hold the corresponding Direct button [9] (7 to 12) for 1 second or longer to select the desired disc.

\* If a CD is not loaded in a slot of the magazine, pressing the Direct button [9] corresponding to its disc number is invalid.

### Selecting a track

#### ● Track-up

1. Press the right side of SEARCH button [14] to move ahead to the beginning of the next track.
2. Each time you press the right side of SEARCH button [14], the track advances ahead to the beginning of the next track.

#### ● Track-down

1. Press the left side of SEARCH button [14] to move back to the beginning of the current track.
2. Press the left side of SEARCH button [14] twice to move to the beginning of the previous track.

### Fast-forward/fast-backward

#### ● Fast-forward

Press and hold the right side of SEARCH button [14] for 1 second or longer.

#### ● Fast-backward

Press and hold the left side of SEARCH button [14] for 1 second or longer.

### Top function

The top function plays from the first track (track No. 1) of the disc.

#### ● When playing a disc 1 to 6

Press the Direct button [9] (1 to 6) with the same number as the CD playing.

#### ● When playing a disc 7 to 12 (only when a 12 disc CD changer is used.)

Press and hold for 1 second or longer the Direct button [9] (7 to 12) with the same number as the CD playing.

\* If a CD is not loaded in a slot of the magazine, pressing the Direct button [9] corresponding to its disc number is invalid.

### Scan play

The scan play locates and plays the first 10 seconds of each track on a disc automatically. This function continues on the disc until it is canceled.

\* The scan play is useful when you want to select a desired track.

1. Press SCN button [5] to start track scanning. "SCN" lights in the display.
2. To cancel the scan play, press SCN button [5] again. "SCN" goes off from the display and the current track continues to play.

### Disc scan play

The disc scan play locates and plays the first 10 seconds of the first track on each disc in the currently selected CD changer. This function continues automatically until it is canceled.

\* The disc scan play is useful when you want to select a desired CD.

1. Press and hold SCN button [5] for 1 second or longer. "DISC" and "SCN" light in the display and the disc scan play starts.
2. To cancel the disc scan play, press SCN button [5] again. "DISC" and "SCN" go off from the display and the current track continues to play.

### Repeat play

The repeat play continuously plays the current track. This function continues automatically until it is canceled.

1. Press RPT button [6]. "RPT" lights in the display and the current track is repeated.
2. To cancel the repeat play, press RPT button [6] again. "RPT" goes off from the display and normal play resumes.

### Disc repeat play

After all the tracks on the current disc have been played, the disc repeat play automatically replays the current disc over from the first track. This function continues automatically until it is canceled.

1. Press and hold RPT button [6] for 1 second or longer. "DISC" and "RPT" light in the display and the disc repeat play starts.
2. To cancel the disc repeat play, press and hold RPT button [6] again. "DISC" and "RPT" go off from the display and normal play resumes on the current track.

### Random play

The random play selects and plays individual tracks on the disc in no particular order. This function continues automatically until it is canceled.

1. Press RDM button [7]. "RDM" lights in the display and the random play begins.
2. To cancel the random play, press RDM button [7] again. "RDM" goes off from the display and normal play resumes.

### Disc random play

The disc random play selects and plays individual tracks or discs automatically in no particular order. This function continues automatically until it is canceled.

1. Press and hold RDM button [7] for 1 second or longer. "DISC" and "RDM" light in the display and the disc random play starts.
2. To cancel the disc random play, press and hold RDM button [7] again. "DISC" and "RDM" go off from the display and normal play resumes from the current track.

# MD Changer Operations

## MD changer functions

When an optional MD changer is connected through the CeNET cable, this unit controls all the MD changer functions. This unit can control a total of 2 changers (MD and/or CD).

Press FNC button [3] and select the MD changer mode to start play. If 2 MD changers are connected, press FNC button [3] to select the MD changer for play.

\* If "NO DISC" appears in the display, load MDs into the MD changer.

## Pausing play

1. Press Play/pause button [2] to pause play. "PAUSE" appears in the display.
2. To resume play, press Play/pause button [2] again.

## Switching disc titles and track titles

This unit can display disc titles and track titles already entered on MDs. Titles up to 128 characters long can be displayed by scrolling the titles.

\* Titles cannot be entered for MDs with this unit.

1. Press DISP button [10] to display the title. The disc title or track title is displayed.
2. Each time you press and hold DISP button [10] for 1 second or longer, the display toggles between the disc title and the track title.

### ● Scrolling titles

When a title is longer than 11 characters, you can scroll through it with the following operation.

1. Display the MD title (disc or track).
2. Press TITLE button [4].

The display scrolls through the title.

## Selecting an MD

Each of the Direct button [9] corresponds to an MD loaded into the MD changer. Press the corresponding Direct button [9] (1 to 6) to select the desired disc.

\* If an MD is not loaded in a slot of the MD changer, pressing the Direct button [9] corresponding to its disc number is invalid.

## Selecting a track

### ● Track-up

1. Press the right side of SEARCH button [14] to move ahead to the beginning of the next track.

2. Each time you press the right side of SEARCH button [14], the track advances ahead to the beginning of the next track.

### ● Track-down

1. Press the left side of SEARCH button [14] to move back to the beginning of the current track.
2. Press the left side of SEARCH button [14] twice to move to the beginning of the previous track.

## Fast-forward/fast-backward

### ● Fast-forward

Press and hold the right side of SEARCH button [14] for 1 second or longer.

### ● Fast-backward

Press and hold the left side of SEARCH button [14] for 1 second or longer.

## Top function

The top function plays from the first track (track No. 1) of the disc. Press the Direct button [9] (1 to 6) with the same number as the MD playing.

\* If an MD is not loaded in a slot of the MD changer, pressing the Direct button [9] corresponding to its disc number is invalid.

## Scan play

The scan play locates and plays the first 10 seconds of each track on a disc automatically. This function continues on the disc until it is canceled.

\* The scan play is useful when you want to select a desired track.

1. Press SCN button [5] to start track scanning. "SCN" lights in the display.
2. To cancel the scan play, press SCN button [5] again. "SCN" goes off from the display and the current track continues to play.

## Disc scan play

The disc scan play locates and plays the first 10 seconds of the first track on each disc in the currently selected MD changer. This function continues automatically until it is canceled.

\* The disc scan play is useful when you want to select a desired MD.

1. Press and hold SCN button [5] for 1 second or longer. "DISC" and "SCN" light in the display and the disc scan play starts.
2. To cancel the disc scan play, press and hold SCN button [5] again. "DISC" and "SCN" go off from the display and the current track continues to play.

### Repeat play

The repeat play continuously plays the current track. This function continues automatically until it is canceled.

1. Press RPT button [6]. "RPT" lights in the display and the current track is repeated.
2. To cancel the repeat play, press RPT button [6] again. "RPT" goes off from the display and normal play resumes.

### Disc repeat play

After all the tracks on the current disc have been played, the disc repeat play automatically replays the current disc over from the first track. This function continues automatically until it is canceled.

1. Press and hold RPT button [6] for 1 second or longer. "DISC" and "RPT" light in the display and the disc repeat play starts.
2. To cancel the disc repeat play, press and hold RPT button [6] again. "DISC" and "RPT" go off from the display and normal play resumes on the current track.

### Random play

The random play selects and plays individual tracks on the disc in no particular order. This function continues automatically until it is canceled.

1. Press RDM button [7]. "RDM" lights in the display and the random play begins.
2. To cancel the random play, press RDM button [7] again. "RDM" goes off from the display and normal play resumes.

### Disc random play

The disc random play selects and plays individual tracks or discs automatically in no particular order. This function continues automatically until it is canceled.

1. Press and hold RDM button [7] for 1 second or longer. "DISC" and "RDM" light in the display and the disc random play starts.
2. To cancel the disc random play, press and hold RDM button [7] again. "DISC" and "RDM" go off from the display and normal play resumes from the current track.

### TV tuner functions

When an optional TV tuner is connected through the CeNET cable, this unit controls all TV tuner functions. To watch TV requires a TV tuner and monitor.

### Watching a TV

1. Press FNC button [3] and select the TV mode.
2. Press BND button [12] to select the desired TV band (TV1 or TV2). Each time the button is pressed, the input selection toggles between TV1 and TV2.
3. Press the right or left side of SEARCH button [14] to tune in the desired TV station.

### Watching a video

The TV tuner has a VTR input terminal to which 1 external device can be connected. Connect a 12V video cassette player (VCP) or video cassette recorder (VCR) to the TV tuner input terminal.

1. Press RDM button [7] to select VTR.
2. To return to the TV broadcast, press RDM button [7].

### Tuning

There are 3 types of tuning mode available. Seek tuning, manual tuning and preset tuning.

### Seek tuning

1. Press BND button [12] and select the desired TV band (TV1 or TV2).
  - \* If "MANU" is lit in the display, press and hold BND button [12] for 1 second or longer. "MANU" in the display goes off and seek tuning is now available.
2. Press the right or left side of SEARCH button [14] to automatically seek a station.

Press the right side of SEARCH button [14] to automatically tune up the frequency band to the next available TV station; press the left side to automatically tune down.



## Manual tuning

There are 2 ways available: Quick tuning and step tuning.

When you are in the step tuning mode, the frequency changes one step at a time. In quick tuning mode, you can quickly tune the desired frequency.

1. Press BND button [12] and select the desired band (TV1 or TV2).

\* If "MANU" is not lit in the display, press and hold BND button [12] for 1 second or longer. "MANU" lights in the display and manual tuning is now available.

2. Tune into a station.

### ● Quick tuning:

Press and hold the right or left side of SEARCH button [14] for 1 second or longer to tune in a station.

### ● Step tuning:

Press the right or left side of SEARCH button [14] to manually tune in a station.

## Recalling a preset station

A total of 12 TV stations can be stored (6-TV1 and 6-TV2). This allows you to select your favorite TV stations and store them in memory for later recall.

1. Press BND button [12] and select the desired TV band (TV1 or TV2).
2. To recall a stored TV station, press the desired Preset button [9] to select that station.
  - \* Press and hold one of the Preset buttons [9] for 2 seconds or longer to store the current station into the preset memory.

## Manual memory

1. Select the desired station with seek tuning, manual tuning or preset tuning.
2. Press and hold one of the Preset buttons [9] for 2 seconds or longer to store the current station to that preset memory.

## Auto store

Auto store selects 6 TV stations automatically and stores each one into a preset memory.

If there are not 6 stations with good reception, stations previously stored in memory remain and only the strong stations are stored into memory.

1. Press BND button [12] and select the desired TV band (TV1 or TV2).
2. Press and hold AS button [5] for 2 seconds or longer. The stations with good reception are automatically stored to the Preset buttons [9].

## Preset scan

Preset scan allows the user to view each preset position before it automatically advances to the next preset. This function is useful for searching for desired TV station in memory.

1. Press PS button [5].
2. When the desired station is found, press PS button [5] again to remain tuned to that station.

### Note:

• Do not press and hold PS button [5] for 2 seconds or longer. Doing so will trigger the auto store function and start storing stations into memory.

## Setting the TV diver

You can change the reception setting for the TV antenna connected to the TV tuner.

1. Press and hold ADJ button [4] for 1 second or longer to switch to the adjustment selection display.
2. Press the right or left side of SEARCH button [14] to select "TV DIVER".
3. Press ENT button [2].
4. Turn the Rotary knob [15] clockwise to set to "ON" or counterclockwise to set to "OFF".

### ON:

Sets reception emphasizing the visual.

### OFF:

Sets the diver setting to OFF.

5. Press ENT button [2].
6. Press ADJ button [4] to return to the previous mode.

# 9. TROUBLESHOOTING

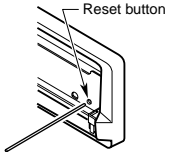
	Problem	Cause	Measure
General	Power does not turn on. (No sound is produced.)	Fuse is blown.	Replace with a fuse of the same amperage. If the fuse blows again, consult your store of purchase.
		Incorrect wiring.	Consult your store of purchase.
	No sound output when operating the unit with amplifiers or power antenna attached.	Power antenna lead is shorted to ground or excessive current is required for remote-on the amplifiers or power antenna.	<ol style="list-style-type: none"> <li>1. Turn the unit off.</li> <li>2. Remove all wires attached to the power antenna lead. Check each wire for a possible short to ground using an ohm meter.</li> <li>3. Turn the unit back on.</li> <li>4. Reconnect each amplifier remote wire to the power antenna lead one by one. If the amplifiers turn off before all wires are attached, use an external relay to provide remote-on voltage (excessive current required).</li> </ol>
	Nothing happens when buttons are pressed.  Display is not accurate.	The microprocessor has malfunctioned due to noise, etc.	Turn off the power, then press the OPEN button <b>1</b> and remove the DCP. Press the reset button for about 2 seconds with a thin rod. 
	DCP or source unit connectors are dirty.	Wipe the dirt off with a soft cloth moistened with cleaning alcohol.	
CD	Compact disc cannot be loaded.	Another compact disc is already loaded.	Eject the compact disc before loading the new one.
	Sound skips or is noisy.	Compact disc is dirty.	Clean the compact disc with a soft cloth.
		Compact disc is heavily scratched or warped.	Replace with a compact disc with no scratches.
Sound is bad directly after power is turned on.	Water droplets may form on the internal lens when the car is parked in a humid place.	Let dry for about 1 hour with the power on.	

# 10. ERROR DISPLAYS

If an error occurs, one of the following displays is displayed.  
Take the measures described below to eliminate the problem.

	Error Display	Cause	Measure
CD	<b>ERROR 2</b>	A CD is caught inside the CD deck and is not ejected.	This is a failure of CD deck's mechanism and consult your store of purchase.
	<b>ERROR 3</b>	A CD cannot be played due to scratches, etc.	Replace with a non-scratched, non-warped disc.
	<b>ERROR 6</b>	A CD is loaded upside-down inside the CD deck and does not play.	Eject the disc then reload it properly.
CD changer	<b>ERROR 2</b>	A CD inside the CD changer is not loaded.	This is a failure of CD changer's mechanism and consult your store of purchase.
	<b>ERROR 3</b>	A CD inside the CD changer cannot be played due to scratches, etc.	Replace with a non-scratched, non-warped disc.
	<b>ERROR 6</b>	A CD inside the CD changer cannot be played because it is loaded upside-down.	Eject the disc then reload it properly.
MD changer	<b>ERROR H</b>	Displayed when the temperature in the MD changer is too high and playback has been stopped automatically.	Lower the surrounding temperature and wait for a while to cool off MD changer.
	<b>ERROR 2</b>	An MD inside the MD changer is not loaded.	This is a failure of MD changer's mechanism and consult your store of purchase.
	<b>ERROR 3</b>	An MD inside the MD changer cannot be played due to scratches, etc.	Replace with a non-scratched, non-warped disc.
	<b>ERROR 6</b>	An MD inside the MD changer cannot be played because it is loaded upside-down.	Eject the disc then reload it properly.
		Displayed when a non-recorded MD is loaded in the MD changer.	Load a pre-recorded MD in the MD changer.

If an error display other than the ones described above appears, press the reset button. If the problem persists, turn off the power and consult your store of purchase.

# 11. SPECIFICATIONS

## FM Tuner

Frequency Range:

87.9 MHz to 107.9 MHz

Usable Sensitivity:

11 dBf

50dB Quieting Sensitivity:

17 dBf

Alternate Channel Selectivity:

75 dB

Stereo Separation (1 kHz):

35 dB

Frequency Response ( $\pm 3$  dB):

30 Hz to 15 kHz

## AM Tuner

Frequency Range:

530 kHz to 1710 kHz

Usable Sensitivity:

25  $\mu$ V

## CD Player

System:

Compact disc digital audio system

Usable Discs:

Compact disc

Frequency Response ( $\pm 1$  dB):

10 Hz to 20 kHz

Signal to Noise Ratio (1 kHz):

100 dB

Dynamic Range (1 kHz):

95 dB

Harmonic Distortion:

0.01%

### Notes:

- Specifications comply with EIA Standards.
- Specifications and design are subject to change without notice for further improvement.

## Audio

Maximum Power Output:

160 W (40 W  $\times$  4 ch) (EIAJ)

Continuous Average Power Output:

14 W  $\times$  4, into 4  $\Omega$ , 20 Hz to 20 kHz, 1%THD

Bass Control Action (30 Hz):

$\pm 15$  dB

Treble Control Action (10 kHz):

$\pm 10$  dB

Line Output Level (CD 1 kHz):

4 V

## General

Power Supply Voltage:

14.4 V DC (10.8 to 15.6 V allowable),  
negative ground

Current Consumption:

Less than 15 A

Speaker Impedance:

4  $\Omega$  (4  $\Omega$  to 8  $\Omega$  allowable)

Weight / Source unit:

3.75 lb. (1.7 kg)

Weight / Remote control unit:

1 oz. (30 g) (including battery)

Dimensions / Source unit:

7" (Width)  $\times$  2" (Height)  $\times$  6-1/8" (Depth)  
[178 (W)  $\times$  50 (H)  $\times$  155 (D) mm]

Dimensions / Remote control unit:

1-3/4" (Width)  $\times$  4-5/16" (Height)  $\times$  1-1/8" (Depth)  
[44 (W)  $\times$  110 (H)  $\times$  27 (D) mm]